



A New Instrument for Measuring Microwave Frequencies with Counter Accuracy

FOR SEVERAL years now, it has been possible to measure VHF Signals accurately with electronic counters. These measurements are made by converting a high frequency to a related lower frequency, generally by heterodyning the measured signal with a harmonic of the counter's time base oscillator to derive a suitable difference frequency¹.

For measurements of higher frequencies, a transfer oscillator customarily is used with a counter². The VHF transfer oscillator is tuned until one of its har-

monics zero-beats with the unknown microwave signal and the VHF oscillator frequency is measured with the counter. The frequency of the unknown signal then is calculated after determining which harmonic causes the zero-beat. This technique enables measurements of frequencies up to 40 Gc with an accuracy approaching 1 part in 10⁷.

More recently, significantly better accuracies have been obtained by using a synchronizer with the transfer oscillator³. The synchronizer slaves the transfer oscillator to a sub-multiple of the unknown signal with

¹ "A New Frequency Counter Plug-In Unit for Direct Frequency Measurements to 510 Mc," Hewlett-Packard Journal, Vol. 12, No. 5, January, 1961.

² Dexter Hartke, "A Simple Precision System for Measuring CW and Pulsed Frequencies up to 12,400 Mc," Hewlett-Packard Journal, Vol. 6, No. 12, August, 1955.

³ Albert Benjaminson, "An Instrument for Automatically Measuring Frequencies from 200 Mc to 12.4 Gc," Hewlett-Packard Journal, Vol. 13, No. 3-4, Nov.-Dec., 1961.

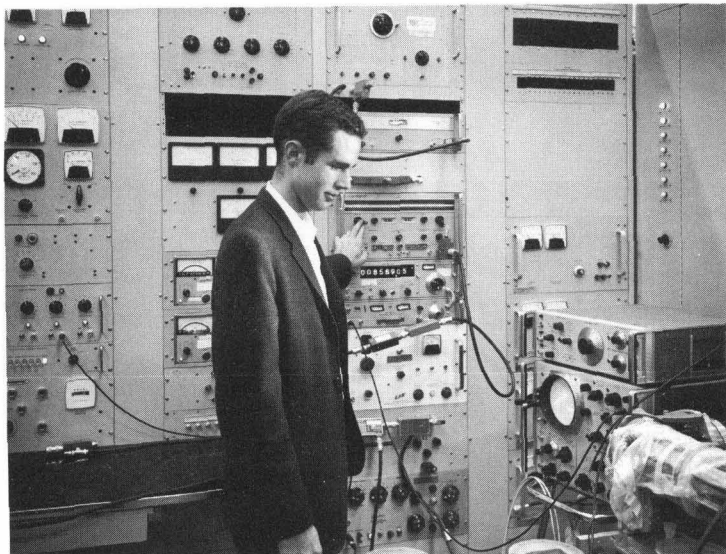

Fig. 1. SLAC research engineer James W. Abraham making measurement at high-power microwave test console at Stanford Linear Accelerator Center being built by Stanford University under contract with Atomic Energy Commission. Accelerator itself, operating at 2856 Mc, accelerates electrons in a 10,000-foot evacuated tube to an energy level of 20 Gev where they reach 99.99999997% of velocity of light. Test frequency here is established to high precision using -hp- Model 2590A Microwave Converter (below counter) with -hp- 5245L Counter.

SEE ALSO:
DC-8 Gc 'scope plug-in, p. 5
New WWV/WWVH time information, p. 8
Crest factor, p. 8

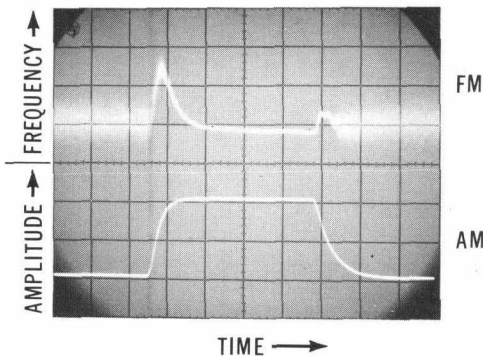

Fig. 2. Scope photo shows incidental frequency modulation on RF pulse as demodulated by -hp- Model 2590A Microwave Frequency Converter. Lower trace shows RF pulse envelope. Upper trace, which monitors FM output of Converter, shows frequency modulation on leading and trailing edges as vertical deflection, where baseline represents RF center frequency.

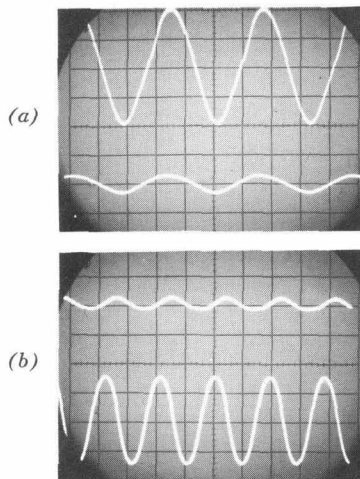

Fig. 3. Scope photos show additional information available from *-hp-* Model 2590A Microwave Frequency Converter. Incidental AM on an FM signal is shown as lower trace in (a) while upper trace shows demodulated FM. Lower trace in (b) shows envelope of AM signal while upper trace shows incidental FM on same signal.

phase-lock oscillator control. The transfer oscillator/synchronizer combination is, in a sense, a precision frequency divider that permits measurement of microwave frequencies with the accuracy of the counter itself, typically 3 parts in 10^6 in late model *-hp-* counters.

THE MICROWAVE FREQUENCY CONVERTER

A new solid-state Hewlett-Packard instrument now combines the transfer oscillator and synchronizer functions in a compact unit that also has several new measurement capabilities. Besides the phase-locked transfer oscillator, the new instrument has independent AM and FM demodulators as well as other useful operating features that extend its applications beyond simple measurements of frequency. For instance, incidental FM on an AM signal, or incidental AM on an FM signal, are measured easily (Fig. 3). The instrument can even indicate the amount and duration of FM or frequency instability that may be on a pulsed microwave signal (Fig. 2).

The instrument, the *-hp-* Model 2590A Microwave Frequency Converter, enables detailed examination of the frequency and modulation characteristics of CW, AM, FM and pulsed microwave signals in a 0.5 to 15 Gc frequency band. It is easy to operate and works with any counter that has a VHF frequency converter capable of measuring the 240-390 Mc transfer oscillator frequency.

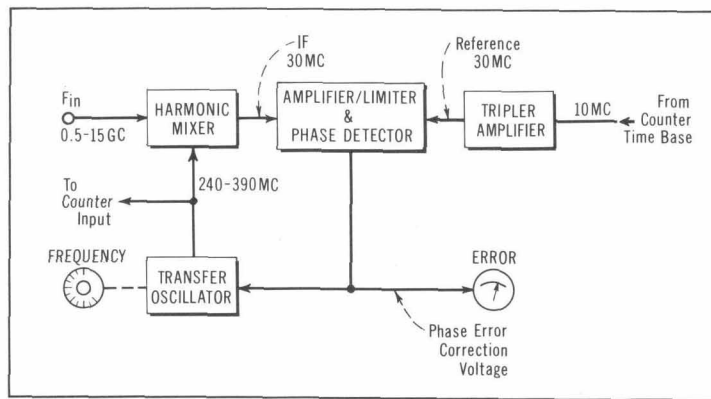

Fig. 4. Skeleton block diagram of *-hp-* 2590A Microwave Frequency Converter in automatic phase control (APC) mode of operation. Automatic phase control locks transfer oscillator to sub-multiple of input frequency for accurate frequency measurement.

BASIC OPERATION

Before describing the varied capabilities of the new instrument, a brief review of the basic principle of operation is in order. A block diagram of the instrument in automatic phase control (APC) operation is shown in Fig. 4. Harmonics of the transfer oscillator output are generated in the harmonic mixer and mixed with the input signal F_{in} . The transfer oscillator is tuned manually until a 30 Mc difference frequency is developed between one of the oscillator harmonic frequencies and the input signal. The difference frequency is amplified and then compared in the phase detector with a 30 Mc reference signal derived from the counter time base.

Any tendency toward frequency change, in either the signal or the transfer oscillator, is sensed immediately as a phase change by the phase detector. This results in a dc correction voltage that is applied to a varactor in the transfer oscillator tank circuit. The varactor adjusts the oscillator frequency to reduce the phase error and as a result, no frequency error exists. In this manner, the transfer oscillator is tuned automati-

cally to maintain a precise 30 Mc beat frequency between the selected harmonic and the input signal.

CW MEASUREMENTS

To measure the frequency of a CW microwave signal, the transfer oscillator is tuned manually until the system locks, as shown by front panel indicators. Obviously, there may be several different oscillator frequencies that provide suitable harmonics for locking to a particular input signal. Lock points, however, occur in pairs since the system locks when the selected harmonic is either 30 Mc above or 30 Mc below the signal. The close-spaced pairing of lock points enables quick identification of the oscillator harmonic number N , as described in the following.

When a suitable lock point has been found, the oscillator frequency is read on the counter and recorded. The oscillator is re-tuned to the companion lock point and this frequency is also recorded. The N th harmonic of the lower oscillator lock frequency, f_{lo} , is 30 Mc below the input frequency while the N th harmonic of the higher lock frequency, f_{hi} , is 30 Mc above the input. Stated another way:

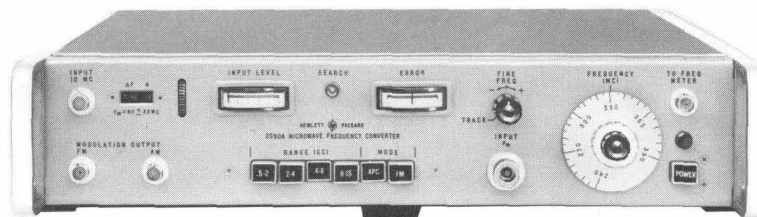

Fig. 5. Hewlett-Packard Model 2590A Microwave Frequency Converter enables accurate counter measurements of microwave frequencies in 0.5 to 15 Gc range. Built-in roll-chart (upper left) simplifies determination of frequency. Converter also has AM and FM demodulators to provide additional information about measured signals. Transfer oscillator may be used independently as 240-390 Mc signal source.



Fig. 6. Microwave Frequency Converter phase-locks built-in transfer oscillator to sub-multiple of microwave input frequency. Counter reads transfer oscillator frequency with characteristic precision. Converter permits measurement of frequencies of CW, FM, AM, and pulsed RF signals.

$$F_{in} = N f_{hi} - 30 = N f_{lo} + 30,$$

(all frequencies in megacycles).

From this, $N = \frac{60}{\Delta f}$, where $\Delta f = f_{hi} - f_{lo}$.

The 2590A has a front panel roll-chart that lists values of N for various values of Δf to reduce the amount of calculation needed for finding the actual input frequency.

A search oscillator automatically adds an audio frequency to the phase correction voltage when the instrument is not locked. This widens the "capture" or pull-in range. A front panel light glows when the search oscillator is in operation but when locking is achieved, the search oscillations are suppressed and the light goes out. This provides a positive indication that a lock point has been found.

A center-zero Error Indicator meter monitors the correction voltage being applied to phase-lock the transfer oscillator. Adjusting the tuning dial while the oscillator is locked moves the meter pointer but does not affect the oscillator frequency, as long as phase lock is maintained. It thus is possible to re-tune the oscillator to track a widely drifting signal without causing a frequency error⁴. The lock or hold-in range without re-tuning normally is about $\pm 0.25\%$ of the signal frequency around the center of the lock range (e.g., ± 25 Mc at 10 Gc).

Long term records of drift in an input signal can be provided by a strip-chart recorder connected through a digital-to-analog converter to the counter. An indication of short term drift or FM

⁴ The frequency error that could result from existence of a phase error with a drifting signal has been calculated to be less than 5 parts in 10^4 .

on the signal is provided by the phase-correction voltage, which is available at a rear panel connector for display on a recorder or oscilloscope (this voltage is not calibrated, however, since it has only a secondary relationship to frequency). The transfer oscillator, when locked, is able to track FM at deviation rates up to 50 kc.

FM MEASUREMENTS

If detailed information about wide-band FM signals is desired, the instrument is switched to an FM mode of operation. This substitutes a precision FM discriminator for the phase-control loop, as shown in the block diagram of Fig. 7. In the FM mode, the instrument is a highly stable superheterodyne FM receiver in which the harmonics of the transfer oscillator serve as the local oscillator signal. Solid mechanical construction, careful thermal design, and rigid power supply regulation obtain extremely low incidental FM and high frequency stability in the transfer oscillator.

When the instrument is in the FM mode, the error meter monitors the aver-

age discriminator output. A center-scale zero indication occurs whenever the average frequency of the signal in the IF channel is 30 Mc.

To measure the center frequency of wide-band FM signals, a pair of readings on two different oscillator harmonics is obtained, as for CW measurements. The transfer oscillator is tuned until a meter zero, or "null" point, is obtained and the counter reading is recorded, as before. The oscillator is re-tuned to the companion null point for another reading to provide the information needed for determining the input frequency. Precise tuning to a null is facilitated by a separate front panel fine tuning control. Measurements to a precision approaching ± 0.02 Mc are possible with this method.

The discriminator output voltage, calibrated accurately at 5 volts per Mc deviation, is available at a front panel connector for use as an indicator of frequency deviation. The output of an envelope detector, which monitors the signal level in the 30 Mc IF amplifier, is available at all times at a front panel connector. This output enables AM on a signal to be monitored at the same time as FM (Fig. 3).

MEASUREMENT OF PULSED RF

Automatic phase control on pulsed signals obviously is nearly impossible because of the lack of pulse-to-pulse phase coherence and the short duration of typical microwave signal pulses, but the frequency of a pulsed RF signal is measured easily with the aid of the FM discriminator in the new Frequency Converter. For this purpose, an oscilloscope is connected to the FM demodulator output to serve as the tuning indicator.

As shown in the photos of Fig. 8, the height and polarity of an RF pulse at

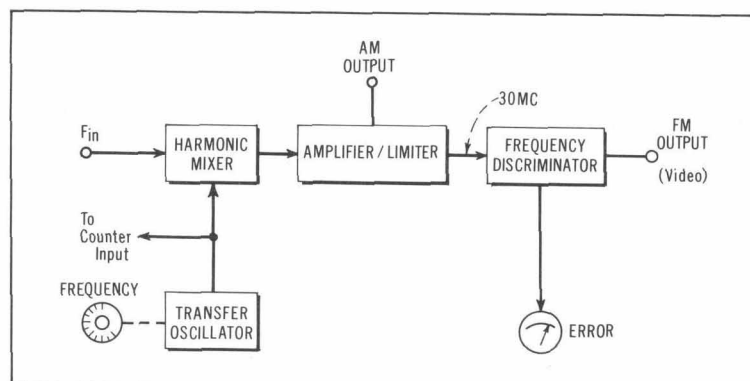

Fig. 7. Block diagram of Microwave Frequency Converter operating in FM mode.

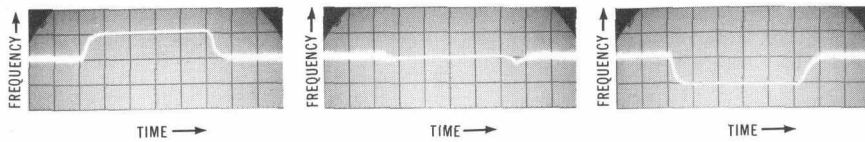

Fig. 8. Microwave Frequency Converter is tuned with aid of oscilloscope to measure frequency of pulsed RF. Three scope photos here show signal from Converter's FM output. In photo at left transfer oscillator frequency is too low and in photo at right it is too high. Correct tuning is shown by zero pulse amplitude in center photo.

the FM output depends on how far the transfer oscillator is detuned away from the "null" frequency. When the harmonic of the transfer oscillator is exactly 30 Mc above or 30 Mc below the pulsed RF frequency, the demodulated pulse top coincides with the zero output voltage level.

As before, the RF frequency is determined by tuning the oscillator to find companion "null" points, and measuring both null frequencies to obtain information for quick calculation of the pulsed RF input frequency. The RF frequency of pulses with widths as short as 0.1 μ sec can be measured with this technique.

The presence of transient voltages on the leading or trailing edge of the displayed waveform, as shown in Fig. 2, indicates the presence of FM on the pulse. The amount of FM can be measured by the deflection amplitude of the scope display, since the discriminator output is calibrated.

STABILIZING NETWORK AND SEARCH OSCILLATOR

A lead-lag (stabilizing) network at the output of the phase detector shapes the

APC loop frequency response to insure stability. Front panel push-buttons switch the network to optimize system performance for several ranges of input frequencies.

A stabilizing network inherently reduces the capture range of an APC system. The capture range of the new instrument, however, is broadened by the search oscillator. By adding an audio frequency component to the phase error correction voltage, the search oscillator increases the likelihood that the transfer oscillator will sweep into a lock frequency. When locking is achieved, the "stiffness" of the phase detector output automatically suppresses the search oscillations without compromising the performance of the APC loop.

ACKNOWLEDGMENTS

The -hp- 2590A Microwave Frequency Converter was designed by the Dymec Division of Hewlett-Packard. The Dymec group that contributed to the electrical design included Albert Benjaminson, Lawrence A. Maguire and Donald R. Willett. Louis W. Belli, Jr., did the mechanical design.

-Rudolph F. Pasos

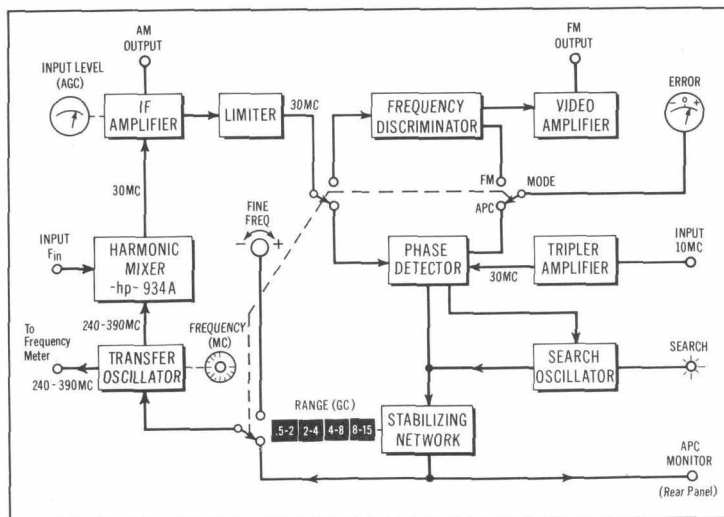

Fig. 9. Detailed block diagram of -hp- Model 2590A Microwave Frequency Converter.

SPECIFICATIONS

-hp-

MODEL 2590A

MICROWAVE FREQUENCY CONVERTER

FREQUENCY RANGE: 0.5 to 15 Gc.

SIGNAL INPUT:

MINIMUM LEVEL: Typically -20 to -30 dbm from 0.5 to 10 Gc, increasing to -7 dbm at 15 Gc.

MAXIMUM LEVEL: +20 dbm (100 mw).

LOCK-ON RANGE: Approximately $\pm 0.25\%$ of signal frequency in normal APC mode. Track mode increases lock-on range to about $\pm 0.45\%$ at 240 Mc end of transfer oscillator range, decreasing to $\pm 0.25\%$ at 390 Mc end.

ACCURACY: \pm stability \pm resolution of measurement of transfer oscillator fundamental.

STABILITY: Same as 10 Mc reference supplied.

RESOLUTION: ± 1 count at transfer oscillator frequency, equivalent to 4.2 to 2.5 parts in 10^9 with 1-second counter gate, or 4.2 to 2.5 parts in 10^{10} with 10-second gate, over 240 to 390 Mc range.

EXTERNAL REFERENCE: 10 Mc, 0.1 v minimum into 90 Ω . Front and rear panel BNC connectors.

FM MODULATION OUTPUT

(Discriminator characteristics):

LINEARITY (max. deviation from straight line through origin): Better than $\pm 1\%$ over bandwidth of ± 500 kc. Better than $\pm 5\%$ over bandwidth of ± 2 Mc.

VIDEO FREQUENCY RESPONSE: 30 cps to 1 Mc (3 db points).

CENTER FREQUENCY: 30 Mc (nominal).

SENSITIVITY: 5 v/Mc ($\pm 10\%$).

OUTPUT IMPEDANCE: 1 kohm.

AM MODULATION OUTPUT:

SENSITIVITY: 100 mv rms out (nominal) for 100% modulation at 1 kc.

FREQUENCY RESPONSE: 30 cps to 1 Mc.

LOAD IMPEDANCE: 1 Megohm shunted by 12 pf max.

APC MONITOR (rear panel BNC connector):

SENSITIVITY: ± 3 v minimum for frequency deviation of $\pm 0.25\%$.

DEVIATION LIMITS: APC mode follows frequency deviations up to $\pm 0.005\%$ of signal frequency at rates from 100 cps to 50 kc (minimum). At rates below 100 cps, deviation limit increases at 6 db/octave to maximum of $\pm 0.25\%$.

IMPEDANCE: Measuring device should have minimum input impedance of 1 Megohm, shunt capacitance not greater than 20 pf.

TRANSFER OSCILLATOR:

FUNDAMENTAL FREQUENCY RANGE: 240 to 390 Mc.

STABILITY (in FM mode): Typically $1/10^9$ per hour immediately after turn-on and less than $1/10^8$ per hour after 2 to 3 hours operation. (Oscillator frequency automatically corrected for drift in APC mode.)

RESIDUAL FM: Less than 10 cps, rms (mainly 60 and 120 cps components).

DIAL: Calibrated in 5 Mc increments.

VERNIER CONTROL: Mechanical, 25:1.

POWER REQUIRED: 115/230 v $\pm 10\%$, 50 to 1000 cps, 35 watts approx.

OPERATING CONDITIONS: Ambient temperatures 10 to 55°C; relative humidity to 95% at 40°C.

DIMENSIONS: Nominally 16 1/4 in. w, 3 1/2 in. h, 16 1/2 in. d, behind panel. Instrument is fully enclosed for use on bench. May be mounted in 19 in. rack with side-extensions to panel (furnished).

WEIGHT: 23 lb (10, 4 kg) net, 28 lb (12, 7 kg) shipping.

ACCESSORIES FURNISHED:

POWER CABLE: Length 7 1/2 ft.

OUTPUT CABLE TO COUNTER: Length 10 1/2 in., BNC-terminated each end, 50 Ω .

REFERENCE INPUT CABLE: Length 15 1/2 in., BNC-terminated each end, 93 Ω .

PRICE: -hp- Model 2590A Microwave Frequency Converter, \$1,900.00.

All prices f.o.b. factory.
Data subject to change without notice.

A NEW DC-4000 MC SAMPLING 'SCOPE PLUG-IN WITH SIGNAL FEED-THROUGH CAPABILITY

The introduction four years ago of the sampling-type oscilloscope extended the frequency range over which signals could be viewed on an oscilloscope to several hundreds of megacycles. A new plug-in unit for the sampling 'scope now permits viewing signals to above 4000 megacycles and does so at higher sensitivity and without disrupting 50-ohm circuits.

THE APPLICATION of the sampling principle to the measurement of high-frequency signals represented a significant break-through in the field of oscilloscopes. Some four years ago the first sampling plug-in produced by *-hp-* (Model 187A) had a bandwidth of 500 megacycles.¹ Two years later a second plug-in² (Model 187B) extended the bandwidth to 1000 Mc. Both of these plug-in units could and can be used with either of the two *-hp-* Sampling Oscilloscope main frames (Models 185A and 185B). Both plug-ins were and are similar in that they employ a sampling gate located in a high impedance (100 kilohm) probe.

A new plug-in has now been developed which displays signals to 4000 megacycles and beyond. Using this plug-in it is practical to measure rise times of 90 picoseconds (90×10^{-12} sec) or less. This is the length of time required for light to travel approximately 1 inch in

¹ Roderick Carlson, "A Versatile New DC — 500 MC Oscilloscope with High Sensitivity and Dual Channel Display," *Hewlett-Packard Journal*, Vol. 11, No. 5-7, Jan.-Mar., 1960.

² Roderick Carlson, "The Kilomegacycle Sampling Oscilloscope," *Hewlett-Packard Journal*, Vol. 13, No. 7, March, 1962.

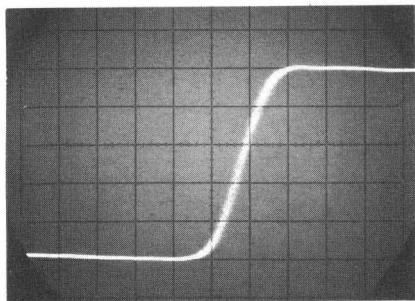

Fig. 2. Typical step response of new plug-in in sampling scope. Sweep speed is 50 picoseconds/cm, showing rise time (10-90%) to be well under 90 picoseconds. In this time light would travel only about one inch.

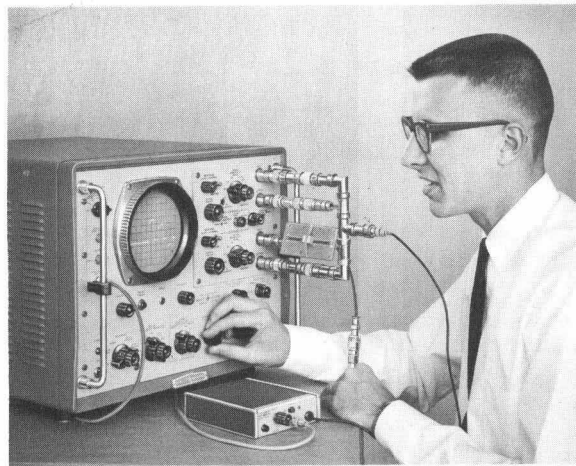

Fig. 1. New Model 188A dual-channel plug-in for *-hp-* Sampling Oscilloscope permits viewing signals of 90 picoseconds rise time, i.e., to above 4 gigacycles in frequency (to 8 Gc at reduced sensitivity). Plug-in is designed to view signals on 50-ohm lines by bridging line so that measured circuit is not disrupted.

air. The rise-time specification of 90 picoseconds makes this instrument the fastest sampling 'scope available today. The new plug-in operates with either of the sampling 'scope main frames mentioned above.

Besides having very wide bandwidth, the new plug-in is designed so that its signal pick-off circuits bridge a signal path that passes completely through the unit. The unit thus uses no probe. Since signals of these frequencies are virtually always confined to 50-ohm lines, the feed-through path has been designed as a 50-ohm system.

It is important that the signal path has been designed as a *feed-through* path, since this arrangement enables the signal to be viewed without significantly disrupting the test circuit under investigation (Fig. 4). Further, since the plug-in is a dual-channel unit, the feed-through arrangement permits such in-

vestigations as comparing an input signal applied to a device on one channel with the output signal from the device on the second channel. The time coin-

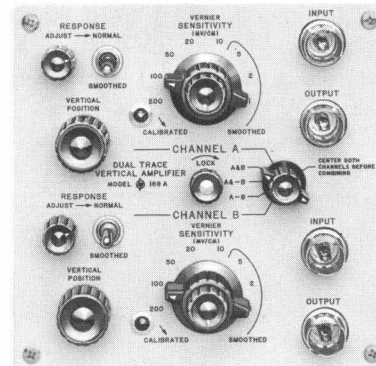

Fig. 3. *-hp-* Model 188A plug-in unit for *-hp-* Model 185A/B Sampling Oscilloscope. Each channel is provided with an output as well as input connector since pick-off circuits bridge the 50-ohm signal circuit.

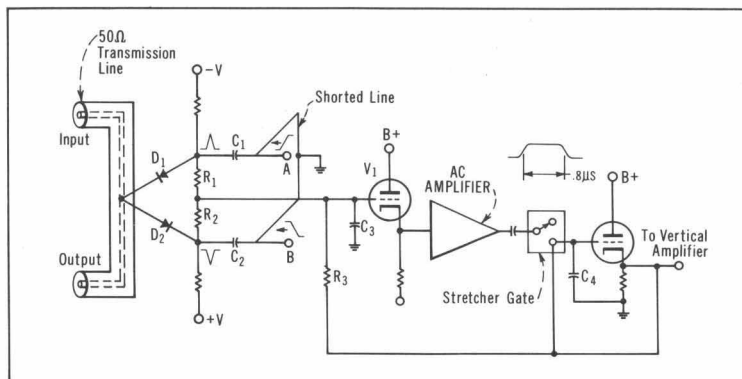

Fig. 4. Basic arrangement of sampling circuit in *-hp-* Model 188A plug-in unit.

cidence of the two channels has been held within 20 ps to permit accurate measurements even at the highest frequencies. This performance is also very valuable in differential display of signals that may have common-mode components.

One of the important characteristics of the sampling scope has always been that it had high sensitivity—even higher than that of most low-frequency oscilloscopes. In the new plug-in this sensitivity has been further increased such that the calibrated sensitivity is now 1 millivolt/cm. This is extendable to 0.4 millivolt/cm with an uncalibrated vernier.

OPERATING PRINCIPLE

In the new plug-in, the sampling gate is composed of only two diodes which are bridged across the 50-ohm feed-through transmission line. Fig. 4 illustrates the two-diode gate and the associated circuitry used in each channel.

A sampling pulse generator provides the positive and negative voltage step which is applied at A and B in Fig. 4. The shorted transmission line converts this step to a pulse which is then coupled through C_1 and C_2 to the reverse-biased sampling diodes D_1 and D_2 . These pulses momentarily forward-bias the sampling diodes, connecting the signal line to capacitors C_1 and C_2 . A sample of the input signal is thus stored on capacitor C_1 or C_2 depending on the polarity of the input. After the sampling interval is completed, the charge stored on C_1 and C_2 leaks off through R_1 and R_2 to the input capacity (C_3) of V_1 . Any voltage change on C_3 is amplified, stretched and applied to the storage capacitor C_4 . The gain of the system is such that although C_3 charges to just a fraction of the input voltage change, the voltage

appearing at C_4 is the same as the input voltage change.

The voltage appearing at C_4 is then fed back to C_3 (and then C_1 and C_2) through R_3 . Thus, before the next sample is taken, the input capacitors C_1 and C_2 are charged to the level of the input voltage during the previous sample. If the gain of this feedback circuit is exactly one, the system is said to be optimized. Even though the sampling circuit has taken only a small charge from the signal line, the vertical display moves completely to the level of the input during one sampling interval.

FOUR-PORT MEASUREMENTS

Since signals to be viewed are normally carried on 50-ohm transmission lines, and the transmission line in the instrument is 50 ohms except for the small discontinuity caused by the sampling diodes, the viewed signal can easily be reconnected to the system under test after it passes through the instrument. This is an important consideration for some sampling measurements. If desired, however, the 50-ohm system can be terminated at the output port. The fact that both the input and output to the 50-ohm sampler are exposed is one of the most useful features available in this instrument. This not only makes the instrument ideal for time domain reflectometry work³ but also provides the user with a great deal of freedom in the general use of the instrument.

One interesting measurement possible with the new plug-in involves the use of all four ports of the instrument along with the A minus B setting of the display selector. Consider the problem of

³ B. M. Oliver, "Time Domain Reflectometry," *Hewlett-Packard Journal*, Vol. 15, No. 6, Feb., 1964.

triggering a very fast tunnel diode and observing the leading edge of the resulting waveform free from any inaccuracy caused by the triggering waveform.

Fig. 6 illustrates how the new plug-in permits such an observation. Here, a trigger pulse is applied simultaneously to both channels A and B through 50-ohm lines. In the output of channel A is connected a dummy capacitance to simulate the impedance of the tunnel diode. The tunnel diode is connected at a corresponding point in the output of channel B.

When the trigger pulse occurs, it passes through channel A and is displayed at an amplitude determined by the line impedance and the dummy impedance. At the same time it passes through channel B and is displayed at the same amplitude. In addition, however, the tunnel diode in the line connected to the input of channel B produces a wave that travels in both directions from the diode. The voltage waveform from the diode is thus displayed on channel B. Note that time coincidence is maintained between the two channels for the trigger. By now using the *A minus B* differential display provision of the plug-in, the trigger pulse can be subtracted out of the display and the tunnel diode waveform viewed by itself. Because of the interconnection of channels the tunnel diode waveform will later appear in channel A, but it is delayed in time and does not interfere with the leading edge of the diode waveform, which was the part to be observed.

An oscillogram of a tunnel diode switching waveform made using this technique is shown in Fig. 7.

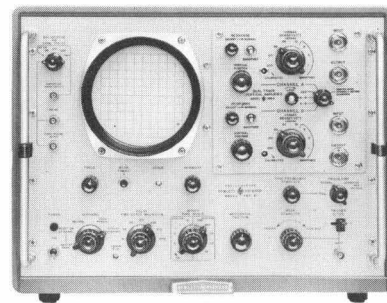

Fig. 5. Model 188A plug-in unit installed in 185A Sampling Oscilloscope.

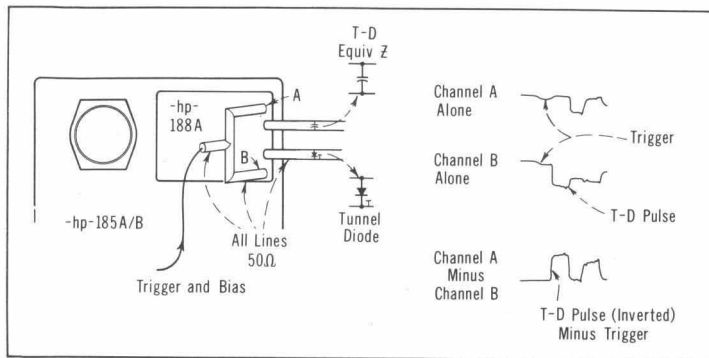

Fig. 6. Arrangement for viewing leading edge of tunnel diode turn-on with $-hp-185B/188A$.

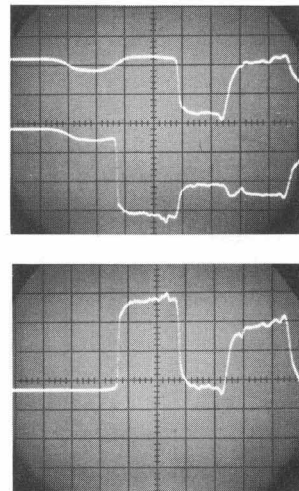

Fig. 7. Oscilloscope waveforms observed in test setup of Fig. 6.

BANDWIDTH

The CW bandwidth of sampling scopes is generally defined in terms of rise time. The most commonly used equation for defining bandwidth is as follows:

$$\text{Bandwidth (Gc)} = \frac{0.35}{t_{R_{10-90\%}} \text{ (nsec)}}$$

It is also possible to measure the CW bandwidth by observing the sampling efficiency while changing the frequency of the input signal. Sampling efficiency (η) is defined as:

$$\eta = \frac{E_{\text{sample}}}{\Delta E_{\text{in}}}$$

The frequency at which the sampling efficiency is down 3 db from its low-frequency level (dc-2000 Mc) is defined as the cutoff frequency of the sampling plug-in. Fig. 8 shows a typical plot of sampling efficiency (η) vs frequency. Although the bandwidth is presently spec-

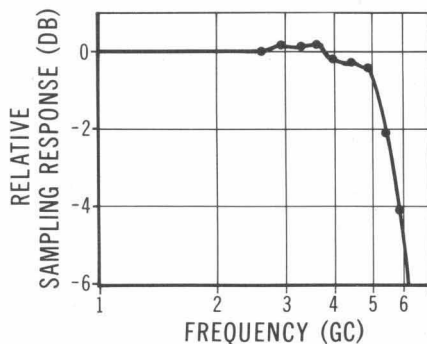

Fig. 8. Typical sampling efficiency vs frequency (frequency response) of $-hp-188A$ plug-in unit in "Normal" response. Bandwidth can be increased to about 8 Gc (-3 db point) by setting "Response Adjust" control.

ified as 4000 Mc or more, the bandwidth of the instrument is generally in excess of 5000 Mc and can be extended farther as discussed next.

RESPONSE VS BANDWIDTH

The rise time of the instrument is equal to the sample time (width of the sample), since this is the minimum time the unit can respond to a perfect step. Since the rise time and bandwidth are directly related, the bandwidth can be controlled by controlling the sample width. Fig. 9 illustrates how the sample width can be varied by adjusting the bias on the sampling diodes.

The bias level on the sampling diodes is adjusted by a front panel control called RESPONSE ADJUST. For a response setting corresponding to Bias #1 in Fig. 9, the sample width would be t_1 . This would correspond to a CW bandwidth of $.35/t_1$. If, however, the RESPONSE control were adjusted to give a bias corresponding to Bias #2, the sample width would be t_2 and the bandwidth would be $.35/t_2$.

Assume that Bias setting #1 is the normal level as determined by the amplifier gain. This would correspond to the condition of optimized response where the sampling efficiency times amplifier gain equals 1, i.e.,

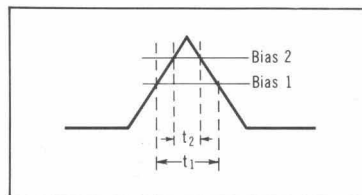

Fig. 9. Drawing showing how changing bias on sampling diodes changes sample width, hence, bandwidth of sampling circuit.

$$\frac{E_{\text{sample}}}{\Delta E_{\text{in}}} \times \frac{\text{Amplifier}}{\text{Gain}} = \text{Loop Gain} = 1$$

The bandwidth for optimized response is specified as 4000 Mc or more. Now if the sampling efficiency is decreased (by adjusting the RESPONSE ADJUST control to give reduced response and increased bias level), the bandwidth will increase since t_2 is less than t_1 . In this manner the maximum bandwidth can be increased to approximately 8000 Mc. It should be noted that since the increased bandwidth is obtained by reducing the sampling efficiency, the system will no longer be optimized, i.e., the loop gain will no longer equal one. This has the effect of reducing the response to random signals (noise) but does not affect the sensitivity to repetitive signals. This is equivalent to operating the instrument with the NORMAL-SMOOTH switch on SMOOTHED, except that here the bandwidth is increased.

INCREASED SENSITIVITY

The sensitivity of the instrument extends from 200 mv/cm to 1 mv/cm in

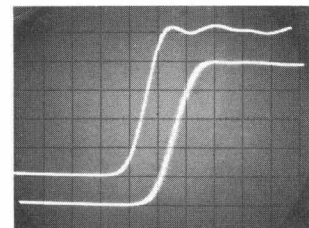

Fig. 10. Oscilloscope showing typical effect of setting "Response Adjust" control. Lower trace (70 psec rise time) shows typical "Normal" response. Upper trace (50 psec rise time) shows "Response Adjust" control set for fastest rise time which increases bandwidth but reduces sensitivity to random signals.

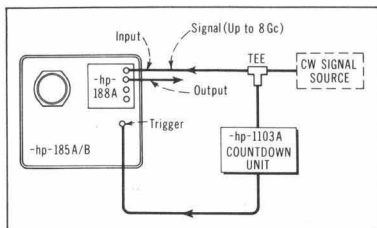

Fig. 11. Arrangement for using -hp- Model 1103A Trigger Countdown Unit to trigger from signals to above 8 Gc.

the calibrated position. The sensitivity can be further adjusted to .4 mv/cm by using the sensitivity vernier control. A screwdriver adjustment on the front panel is provided to calibrate the vertical sensitivity. A calibrator waveform is provided on the main frame. Automatic smoothing is provided on the 5, 2, and 1 mv/cm ranges.

TIME COINCIDENCE BETWEEN CHANNELS

The time coincidence between the two channels of any dual-channel sampling plug-in is determined by the distances between the common sampling pulse generator and the individual channel's sampling diodes. If these distances are equal, the time differential between channels will be zero. In the Model 188A the time coincidence is held to less than 20 picoseconds. This is equivalent to a length differential of approximately $\frac{1}{8}$ inch. Typically, the time difference is less than 10 picoseconds.

8 GC TRIGGERING

In addition to displaying switching and other pulse-type waveforms, the plug-in/oscilloscope combination can, of course, display sine-wave or other CW-type signals. Such signals can, in fact, be viewed to at least twice the nominal 4 Gc 3-db point, i.e., to 8 Gc or more, at a corresponding reduction in sensitivity (Fig. 8).

For triggering on such high frequency signals, the Model 1103A Trigger Countdown Unit has been designed to count down the frequency of the signal to the 1 Gc trigger range of the Model 185B main frame (Fig. 11). It is also possible to use the -hp- Model 213A/B Pulse Generator in the manner shown in Fig. 12 to count down from signals up to 4 Gc or more. In this case a minimum amplitude of 200 mv rms is required, where

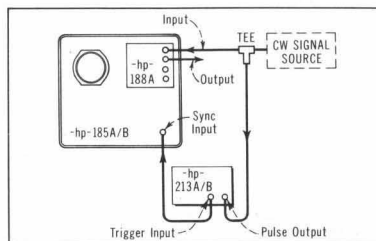

Fig. 12. Arrangement for using -hp- Model 213A/B, reverse-connected as shown, to trigger from signals to 4 Gc.

the Countdown Unit requires only a fraction of this amount.

ACKNOWLEDGMENT

The design and development of the 188A was a joint effort of several members of the Oscilloscope Division. In addition to the undersigned, members of the group were Charles O. Forge, Shigeo S. Nakai, and Bennie E. Helms. Valuable suggestions were provided by A. Roderick Carlson, Kay B. Magleby, and Bernard M. Oliver.

— Wayne M. Grove

SPECIFICATIONS

—hp—

MODEL 188A DUAL TRACE AMPLIFIER (Installed in the 185B)

NUMBER OF CHANNELS: Two (A and B).
MODES OF OPERATION

1. Channel A alone
2. Channel B alone
3. Channel A and Channel B
4. Channel A and (—) Channel B
5. Channel A minus Channel B (differential)

EACH CHANNEL

INPUT IMPEDANCE: 50 ohms, with the line bridged or terminated. To terminate the system under observation, a 50-ohm load may be connected to the output connector.

RISE TIME: Less than 90 psec.

OVERSHOOT: Less than 5%.

SENSITIVITY: 8 calibrated ranges from 1 mv/cm to 200 mv/cm in a 1, 2, 5 sequence. Vernier gives continuous attenuation between ranges and increases the sensitivity to 0.4 mv/cm.

ATTENUATOR ACCURACY: $\pm 3\%$.

DYNAMIC RANGE: ± 1 volt.

NOISE (observed peak-to-peak or measured $3 \times$ rms): Less than 3 mv p-p, 10 mv/cm to 200 mv/cm.

On the automatically smoothed ranges: less than 2 mv p-p at 5 mv/cm, 1 mv p-p at 2 mv/cm, and 0.8 mv p-p at 1 mv/cm.

Smoothed position of "Response" control reduces noise by a factor of two.

ACCESSORIES PROVIDED: Two 50-ohm terminations.

ACCESSORIES AVAILABLE:
-hp- 10201A 5:1 Resistive Divider Probe.
-hp- 10201B 10:1 Resistive Divider Probe.

WEIGHT: Net 7 lbs. (3 kg); shipping 14 lbs. (6.5 kg).

PRICE: 188A Dual Trace Vertical Amplifier \$1,500.00

Prices f.o.b. factory.
Data subject to change without notice.

NEW TIME INFORMATION ADDED TO WWV/WWVH BROADCASTS

National Bureau of Standards radio stations WWV and WWVH will start broadcasting daily corrections to their regular time signals on May 1, 1964 by agreement with the Naval Observatory. By indicating the very small differences between time as broadcast and time on the UT-2 scale, these corrections will enable users to obtain a very accurate value of UT-2. The corrections, in Morse code, will be broadcast on WWV during the last half of the 19th minute of each hour and on WWVH during the last half of the 49th minute of the hour as follows:

UT2 space AD or SU space three digits

The last three digits represent the number of milliseconds to be added or subtracted (as indicated) to the time as broadcast to obtain UT-2. The symbols will be revised on a daily basis, the new value appearing for the first time during the hour after midnight UT.

WWV also broadcasts the frequency offset in Morse code (service started Nov. 15, 1963) immediately following "on-the-hour" voice announcements. The frequency offset is the difference between the standard broadcast frequency, based on the UT-2 time scale, and the U. S. Frequency Standard which is based on atomic time (AT). At present, the offset symbol is M150, which means that the nominal standard broadcast frequency is offset minus 150 parts in 10^6 from the U. S. Frequency Standard.

Propagation forecasts in Morse code now follow code time announcements every five minutes.

CREST FACTOR AND PULSE TRAINS...

The closing paragraph in the article "Derivation of Crest Factor" (January, 1964 issue*) described the calculation for combining ac and dc voltage measurements to obtain the rms value of a waveform having both ac and dc components. It should be noted that this technique applies when the rms voltmeter circuits are ac-coupled, as they are in the -hp- Model 3400A RMS Voltmeter discussed in that article. RMS measurements with rms voltmeters that are dc-coupled do not, of course, require a separate dc measurement.

*"An RMS-Responding Voltmeter with High Crest Factor Rating," Hewlett-Packard Journal, Vol. 15, No. 5, Jan, 1964.